

# MODEL PT-130 POWER TILT AND TRIM OWNER'S MANUAL

## FOREWORD

Thank you for choosing a CMC product. This manual is designed to aid in installation and maintenance of your PT-130. Each part of the CMC PT-130 is precision machined from the highest quality material to insure many years of trouble free service.

## CONTENTS

Foreword .....	Outside Front Cover
Installation .....	Inside Front Cover
Warranty Card .....	Centerfold
Servicing .....	Page 7
Actuator Removal .....	Page 8
Parts List .....	Inside Back Cover
Troubleshooting .....	Inside Back Cover
Warranty .....	Outside Back Cover



# COOK MANUFACTURING CORPORATION



# INSTALLATION

The CMC PT-130 has been predrilled to fit standard B.I.A. outboard motor mounting hole configurations. If your boat and motor is not drilled to these specifications, some drilling may be necessary. Consult an installation manual for your outboard for proper mounting dimensions. Be sure to use at least 1/2" diameter stainless steel bolts and nuts for mounting the PT-130 to boat. A convenient adapter kit is available at CMC for mounting smaller motors to the PT-130 that are mounted with transom clamps.

For proper installation the following items should be included in your PT-130 box:

## MODEL PT-130 POWER TILT AND TRIM

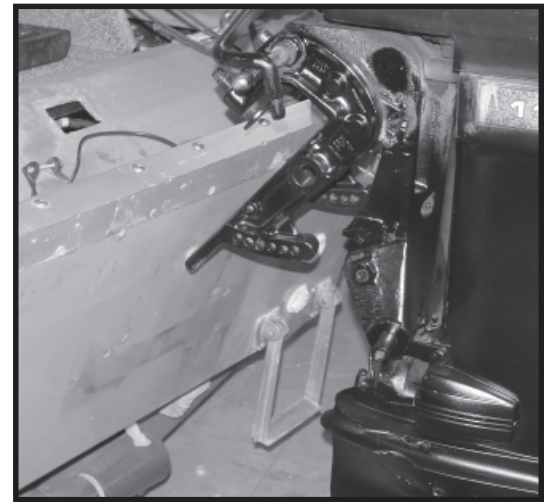
1. One hydraulic PT-130 unit
2. One wire assembly
3. One trim gauge and wire assembly (optional)
4. Four 1/2" - 13 x 3 stainless steel hex head cap screws
5. Four 1/2" - 13 stainless steel hex nuts
6. Four 1/2" stainless steel lock washers
7. Four 1/2" stainless steel flat washers
8. One up-down toggle switch

Step 1: Consult outboard motor manual or dealer for proper outboard motor lifting procedures. You will need to lift the motor in some fashion with a lifting device rated at the proper lifting capacity.

Step 2: Attach lifting device to motor making sure motor is supported safely.

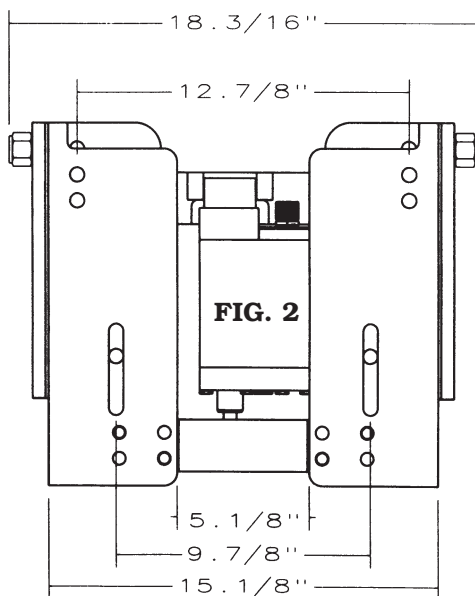
Step 3: Remove four nuts that presently mount motor to transom of boat.

Step 4: Swing motor away from boat taking care not to damage any wires or cables. (Fig. 1 )

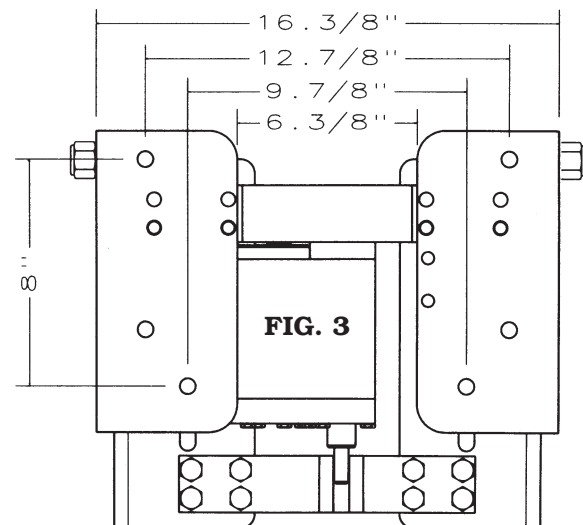


**FIG. 1**

The figures below show the transom view (Fig. 2) and the motor view (Fig. 3) of the PT-130. The transom view to the transom and the motor view to the motor (the side with the decal to the motor).



**TRANSOM VIEW**



**MOTOR VIEW**

Step 5: Mount the PT-130 unit on boat transom by use of four predrilled holes in transom of boat (for standard B.I.A. motors). (Fig 4.) Mount the tilt high enough for clearance of motor and transom when fully tilted. If a motor with transom clamps was previously mounted to boat, use the PT-130 transom side as a template and drill holes through the transom accordingly.

In most installations, so that you will have proper clearance, it is best when mounting the PT-130 to the boat to insert the mounting bolts from the inside of the PT-130 out (the head of the bolt inside of the PT-130 and the nut on the inside of the boat). However, for this installation, we could insert from outside in with the mounting bolts without causing a clearance problem.

We used a CMC power-lift transom washer plate in this application. (Fig. 5). The transom washer plate can eliminate embedding of bolt heads into the transom by more evenly distributing the load.

Step 6: Fasten unit to transom with nuts previously used for motor, making sure to use flat washer and a lock washer before the nut.

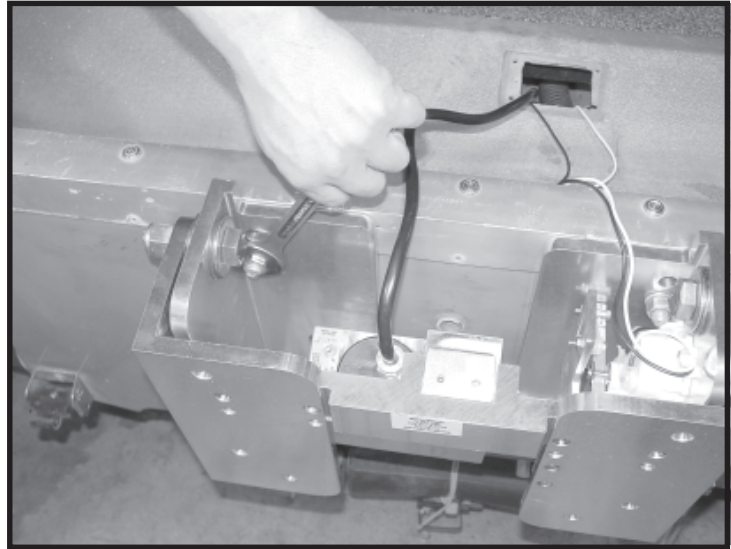


FIG. 4

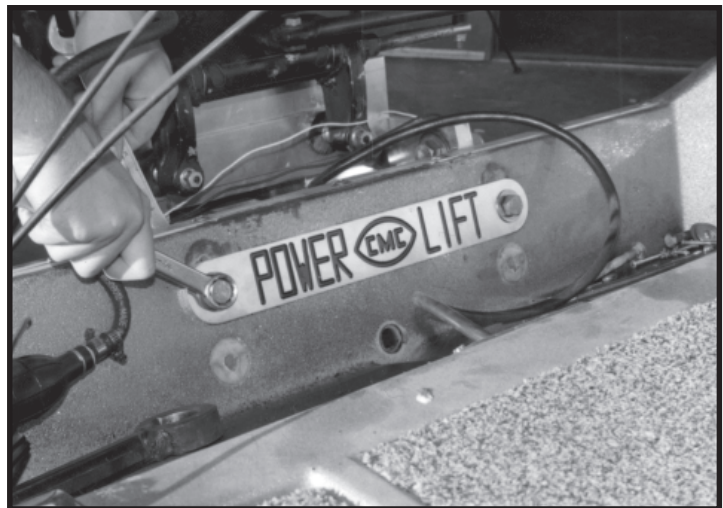


FIG. 5

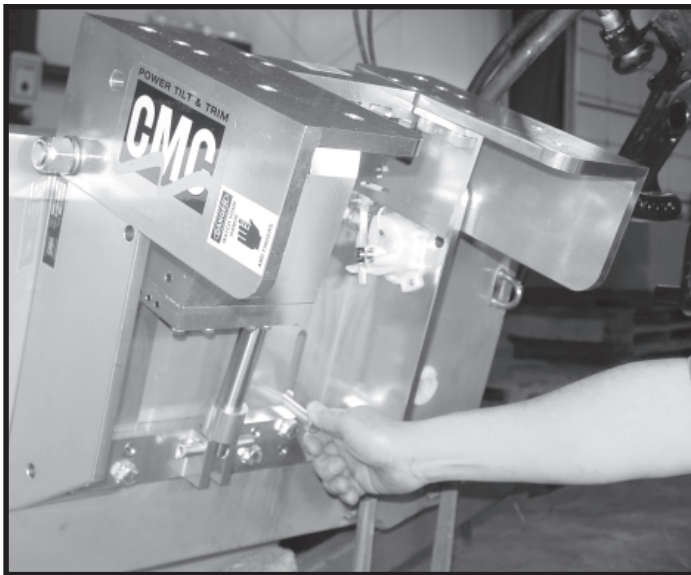


FIG. 6

**NOTE: To make the bottom mounting holes more accessible, mount the PT-130 to the transom at the top. Then follow the instructions on page 4 to obtain power to the PT-130. Tilt the PT-130 up to allow access to the bottom mounting holes.**

Be sure to use at least four 1/2" diameter stainless steel bolts and nuts for mounting the PT-130 to boat. Mount it high enough for clearance of motor and transom when fully tilted. (Fig. 6)

## STANDARD MOUNTING

Step 7: The PT-130 is designed for 130 h.p. and smaller motors. Mount standard B.I.A. motor on the PT-130 using the four predrilled holes (FIG. 7) and the 1/2" - 13 X 3 bolts, 1/2" - 13 hex nuts and washers furnished with the unit.

When mounting a standard motor, take into consideration that your motor will set back from transom 6 inches. This allows you to mount your motor higher than you can when it is mounted to the transom (because as the water passes under your transom it comes up toward your propeller). When mounting the motor to the PT-130, the cavitation plate of your motor should be 1 to 3 inches above the bottom of the boat for best performance results.

**CAUTION:** When mounting your motor higher make sure that it is not mounted so high that you lose water pressure at top end speed.

**NOTE:** To insure proper internal clearance, insert bolt with threads protruding toward motor. Make sure all nuts and bolts are tight. These should be rechecked frequently for correct tightness. Also, when tilting all the way up, you have proper clearance for motor and transom.

Most steering cables have plenty of extra length to allow enough movement to install motor to the PT-130 without disconnecting them, although on some models disconnecting and lengthening may be necessary.

**WHEN MOUNTING A 2-PIECE TRANSOM MOUNT MOTOR TO THE PT-130, USE FOUR BOLTS (TWO ON EACH SIDE) THROUGH THE 2-PIECE MOUNTING BRACKETS AND TWO ADDITIONAL BOLTS (ONE ON EACH SIDE) THROUGH THE MAIN STRUCTURE OF THE MOTOR. (FIG. 8)**

## ADAPTER KIT FOR TRANSOM CLAMP MOUNTED MOTORS

For installation of motors mounted with transom clamps, an adapter kit is available from CMC. This adapter kit is made for quick and easy installation of these type motors. (FIG. 9)

Step 7A: Loosen the two hex head bolts with a 3/8" hex key wrench enough to allow the top adapter piece to fit over the motor side of the PT-130. Place the top adapter piece on top of the motor side of the PT-130. (FIG. 10 and 11).

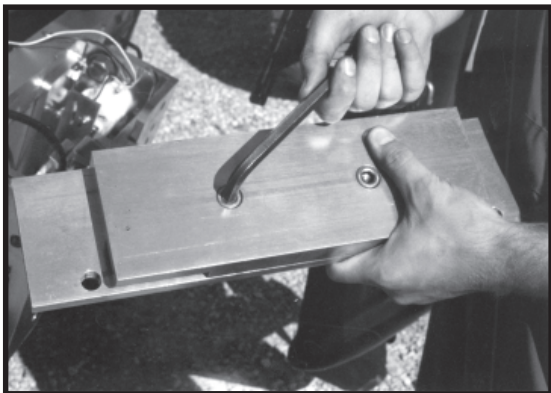


FIG. 10

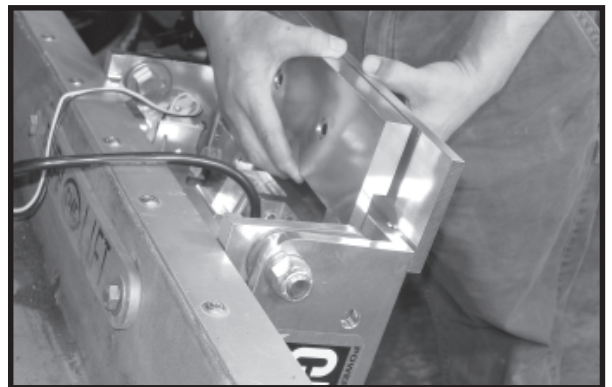


FIG. 11

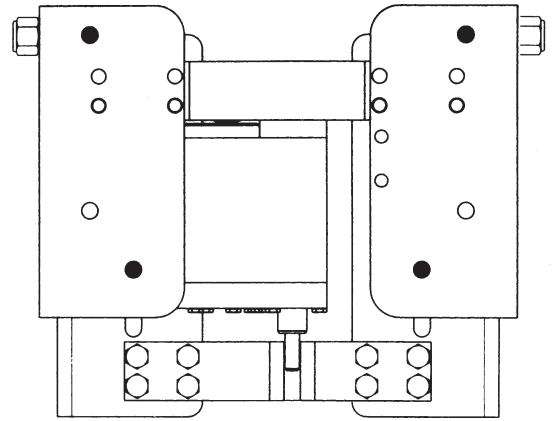


FIG. 7

If mounting the motor as shown in FIG. 8 with the bolts coming from the outside of the PT-130 structure in (head of the bolts on the outside) causes internal clearance problems, reverse the bolts so they come from the inside of the PT-130 structure out (head of the bolt inside of the PT-130 structure.)

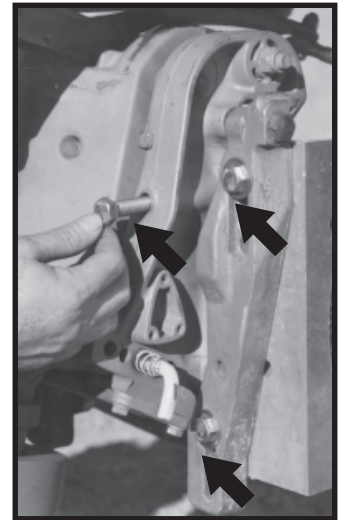


FIG. 8

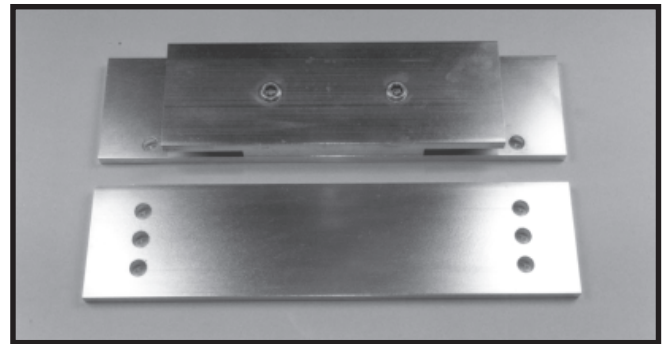
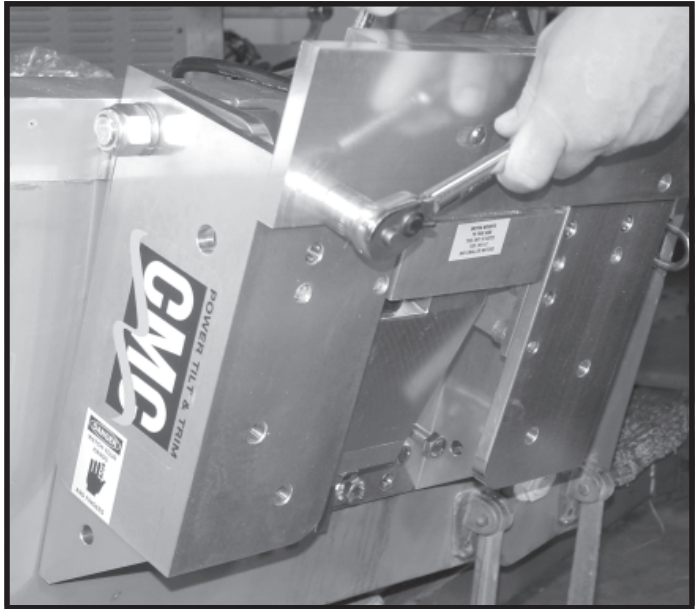


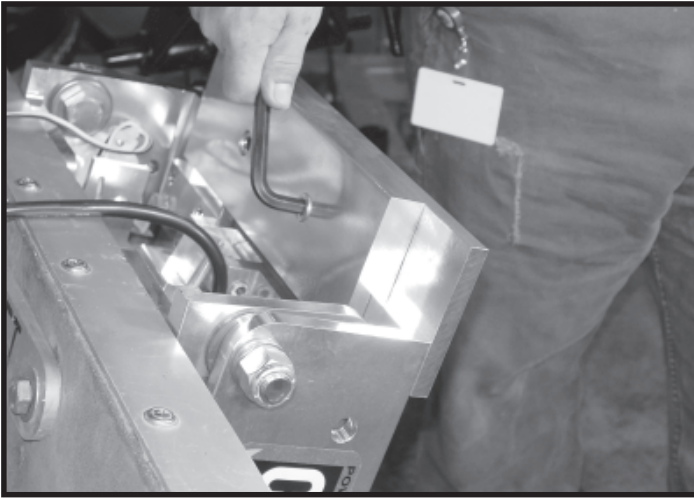
FIG. 9

Step 7B: Line up the two holes of the adapter plate with top two mounting holes of the PT-130. Insert bolts and tighten. (FIG. 12)

Step 7C: Tighten the hex head bolts in the top adapter plate. (FIG. 13)



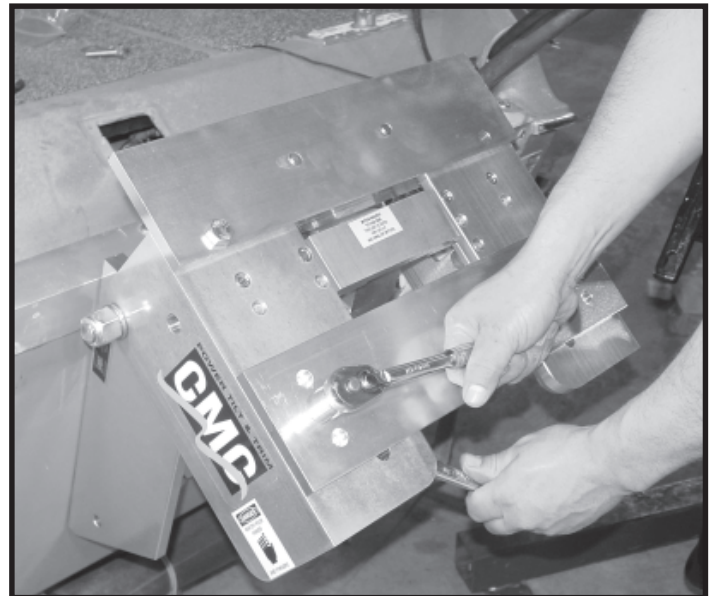
**FIG. 12**



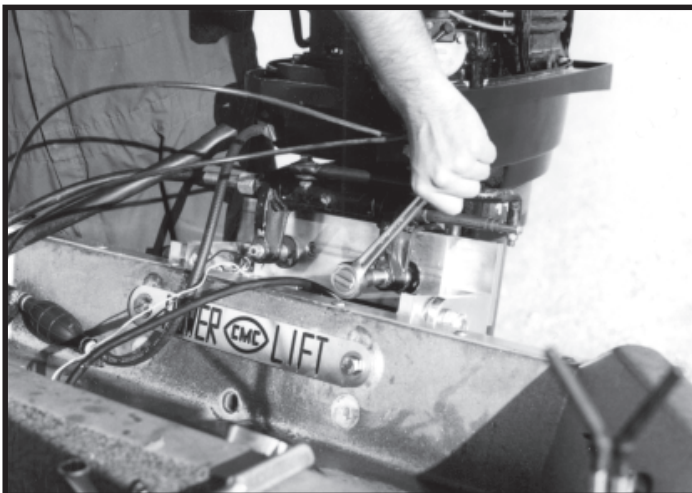
**FIG. 13**

Step 7D: Mount the bottom adapter plate to the PT-130. There are three adjustment holes on this plate. Mount it at the right height so when the motor is mounted the bottom feet of motor mounting bracket rest securely on the bottom adapter plate. (FIG. 14)

Step 8: Center motor on the PT-130 and tighten clamp bolts to adapter plate (FIG. 15)

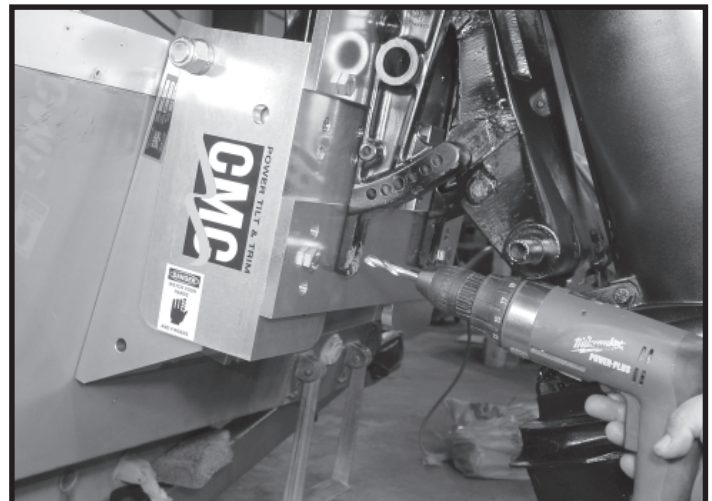


**FIG. 14**



**FIG. 15**

Drill two holes for mounting the bottom of the motor to the bottom adapter plate. To insure proper internal clearance, insert bolts with threads protruding towards motor. Make sure nuts and bolts are tight. (FIG. 16)



**FIG. 16**

## TRANSOM SPACER FOR PONTOON BOAT

To install the PT-130 Power Tilt & Trim to a pontoon boat, the pontoon spacers may be needed. The transom on some pontoon boats are inset with an aluminum lip along the sides. The transom spacers are 1 inch thick allowing you to mount the PT-130 without interference with the lip around the transom. Mount the transom spacers to the pontoon transom as shown in Figure 17. Mount the PT-130 with bolts through the same holes that are through the spacers and transom (B.I.A. hole pattern).

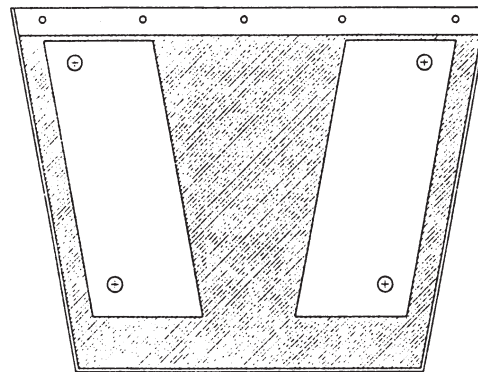


FIG. 17

Step 9: Find a good location for the up-down toggle switch. This toggle switch should be located for easy access while operating the throttle. Use a 1/2 inch drill to drill a hole at the chosen location taking care not to damage wires or brackets. (Fig. 18)

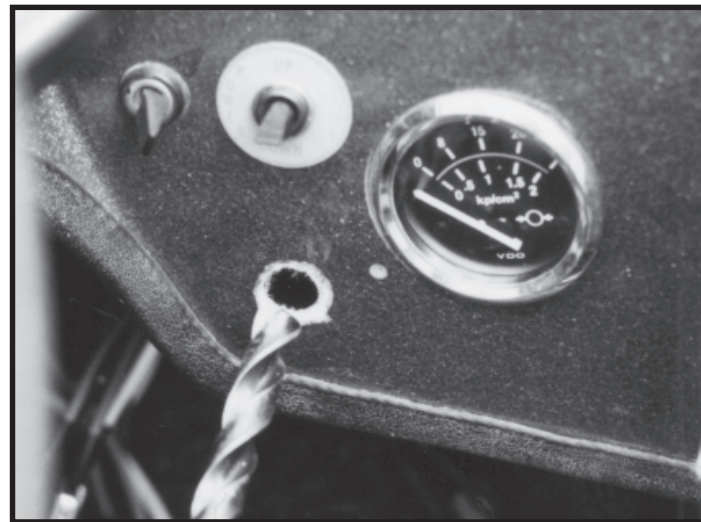


FIG. 18

Step 10: Locate the wires on the wire assembly;

1. One labeled **up**;
2. One labeled **down**;
3. One labeled **12V**.

Locate the keyway on the toggle switch. Position the switch so that the keyway on the switch is up. Connect the **down** wire to the top post. Connect the **12V** wire to center post. Connect the **up** wire to the bottom post. (Fig. 19)

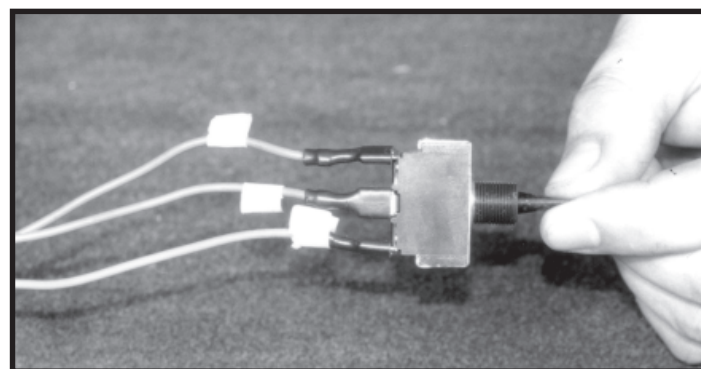


FIG. 19

Step 11: Push the toggle switch through the 1/2" hole that you previously drilled. Place the up-down switch plate and rubber boot with nut on the switch. (Fig. 20)

Step 12: Connect the 2-wire male connector from the hydraulic power unit to the female 2-wire connector at the end of the wire assembly. (Fig. 21)

Find a dry location for the two 40 amp relays and secure them there.

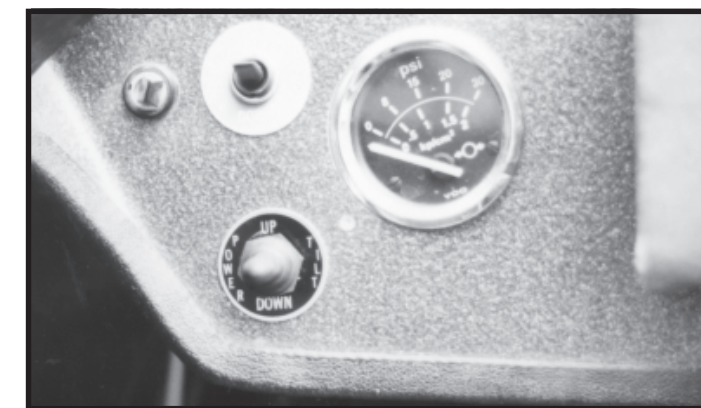


FIG. 20

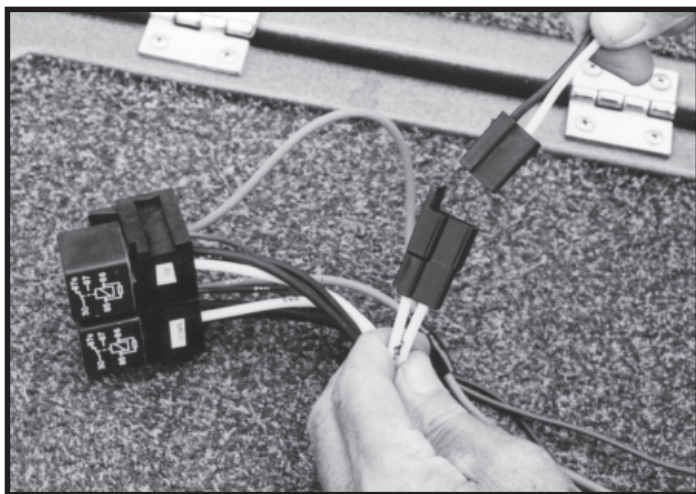


FIG. 21

Step 13: Connect the ring terminal labeled POS to the positive battery terminal and connect the ring terminal labeled NEG to the negative battery terminal. (Fig. 22)

This will make the PT-130 operational. Try the toggle switch up to make sure it tilts up and down to make sure it tilts down.

**NOTE:** If your boat is used in a corrosive environment such as saltwater and you cannot locate a dry place for the relays, you can secure the relays inside of the cowling of your engine. Instead of connecting the positive and negative ring terminals of the wire assembly to the battery, connect to the starter where the positive and negative leads from the battery are attached.

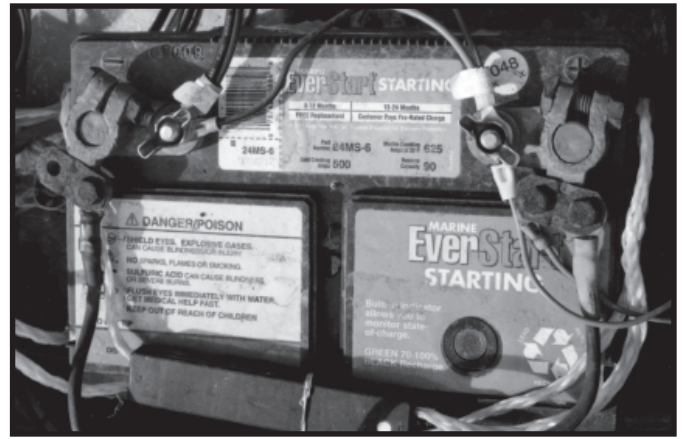


FIG. 22

Step 14: If the PT-130 was purchased with a trim gauge, find a good location for mounting it in your boat. This gauge is used to determine the position of the motor as it is tilted and trimmed. Cut a 2 1/8" hole in the location chosen. Make sure not to cut into any wiring or other brackets. (Fig. 23)

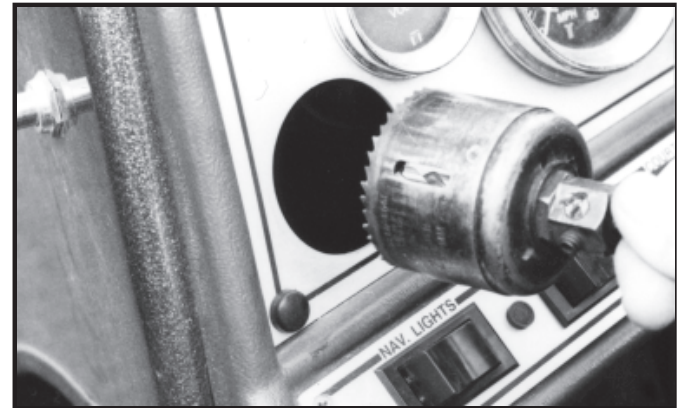


FIG. 23

Step 15: The Trim Gauge wire assembly consist of black and white wires coming from a male connection. The other end of the black wire will have a red pigtail wire and black and red wires with ring terminals. Pull the white wire labeled S, and the black wire labeled -, and the red wires labeled + through the gauge hole you cut. Connect wires to gauge as follows:

- S terminal to S post
- terminal to GND post
- + terminal to I post
- + pigtail to lamp post

(FIG. 24 & 24A)

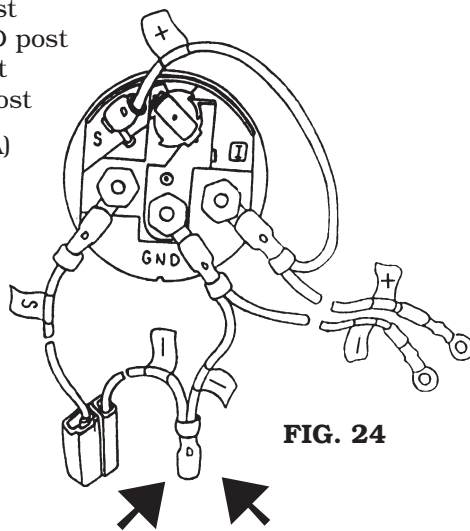


FIG. 24

*This extra pigtail will not be used on the GND (-) wire.*

**Note:** The clamp bracket should be attached to the gauge before the above wires are connected. (Fig. 24A). Figure 24 is shown without the clamp bracket to make it easier for you to see where the wires connect.



FIG. 24A

Push gauge into hole and clamp into hole using clamp and nuts furnished with gauge. (Fig 25)

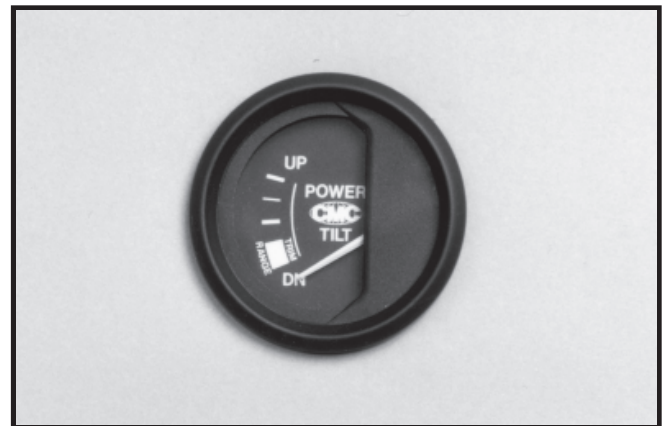


FIG. 25

Step 16: Locate the red wire with the small ring terminal and the black wire with the small ring terminal. These wires supply 12 volt power to the gauge, so they should be connected to the ignition switch using wire tap connectors. This will allow you to use the gauge only when the motor is in operation. The red terminal is for +12 volts DC. The black terminal is for ground.

Step 17: Locate the 2-wire male connector at the other end of the gauge wire assembly and the 2-wire female connector from the trim gauge sending unit and make connection (Fig. 26-27). Now turn on the ignition switch, check lamp illumination in gauge. The light should be on. With the ignition switch on, run the PT-130 up and down. The gauge needle should indicate up and down movement. If these things operate correctly your PT-130 Power Tilt and Trim is ready for operation.

The PT-130 will tilt your motor a total of 90 degrees. While the boat is underway, the PT-130 will trim your motor a total of 20 degrees (see trim range below), but will not tilt the motor. When the boat is slowed or stopped it will allow you to tilt the motor the full range for shallow running or trailering.



FIG. 26

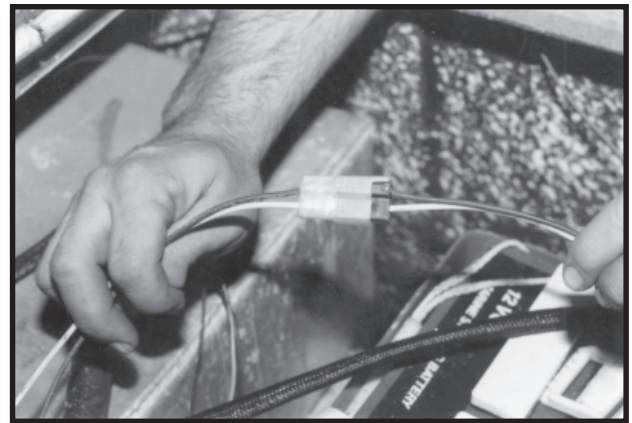
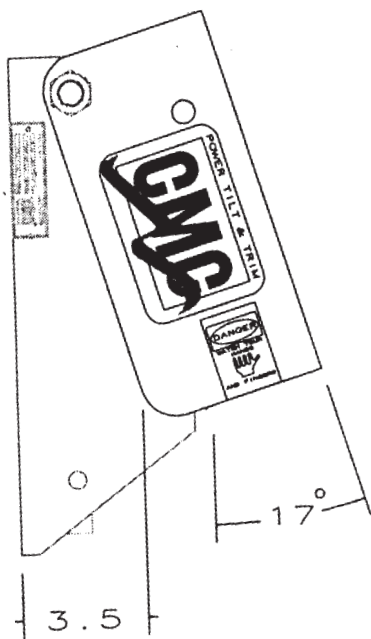
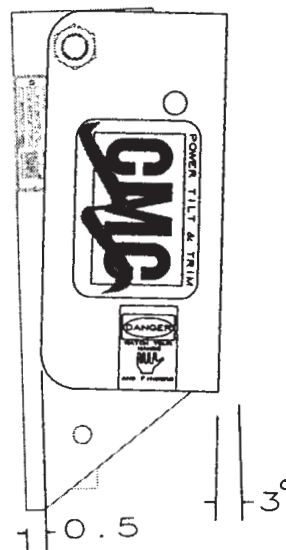


FIG. 27

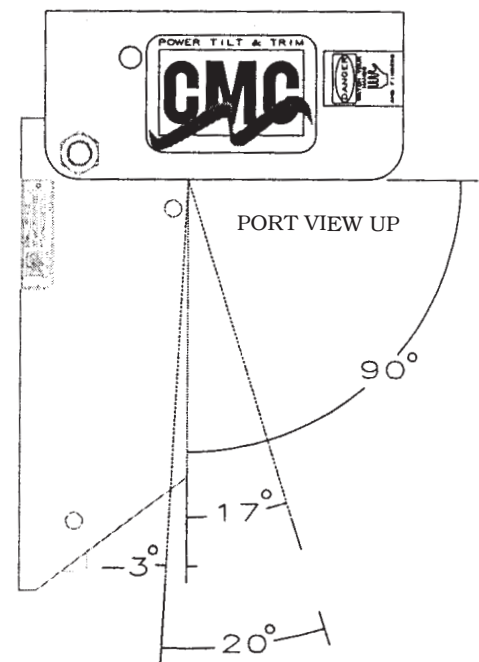
**CAUTION: WHEN TILTING ALL THE WAY UP, MAKE SURE YOU HAVE ENOUGH CLEARANCE BETWEEN YOUR MOTOR COWLING AND THE BOAT. WHEN TRAILERING IT IS RECOMMENDED TO SUPPORT THE PT-130 WITH A TRANSOM SAVER DEVICE.**



UNIT SHOWN AT MAX. TRIM RANGE  
Diagram 1



3° NEGATIVE TRIM  
Diagram 2



TILT & TRIM RANGE  
Diagram 3



## SERVICING

Your CMC PT-130 is operated with a hydraulic actuator which is located inside the Tilt & Trim. It is filled with the correct amount of hydraulic fluid and tested at the factory. If it becomes necessary to add fluid to the actuator, use #2216 Mystic or equivalent, SAE 20 or 30 non detergent oil. The procedure for adding fluid and bleeding the system are as follows

First, trim the PT-130 all the way down. Remove the 1/8" brass socket fillet plug with a 3/16" hex key wrench (FIG. 28). Next, remove the 1/8" brass socket level plug with the same wrench (FIG. 29). Pour fluid into the actuator through the filler hole until the fluid runs out of the level hole on the side of the actuator (FIG. 30). Run the actuator until the ram is fully extended and the motor bogs down (PT 130 tilted all the way up). Then retract the ram completely until the motor bogs down (trim the motor all the way down). Replace the level plug (FIG. 31). Tilt the PT-130 out until the ram is extended 2 to 3 inches out of the actuator (FIG. 32). Then, replace the filler plug.

If preferred, the above procedure can be executed with the actuator completely removed. Please see the next page for the procedure for removal of the actuator.



FIG. 30



FIG. 28



FIG. 31



FIG. 29

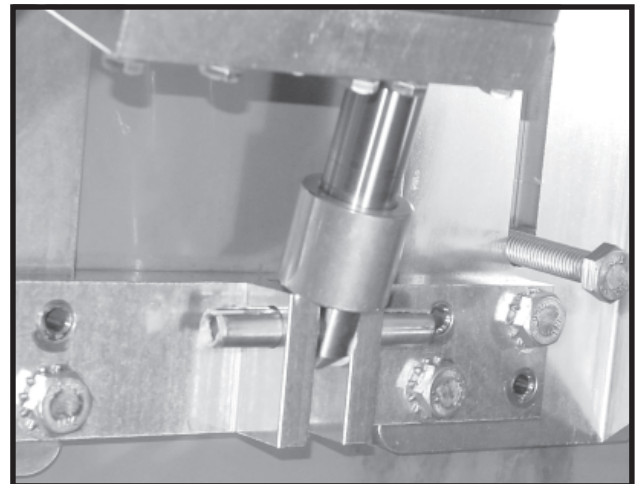


FIG. 32

## ACTUATOR REMOVAL

There are holes machined into the transom rails and motor rails of the PT-130 to allow easy access with a 1/2" to 7/16" diameter driver bar (driver bar available from CMC) for removal of the two actuator spring pins (Fig. 33). One spring pin is located at the top of the actuator and the other is located at the bottom of the ram.

Trim the PT-130 all the way down so the two top access holes of the motor rails and transom rails line up. Next, insert the driver bar through the bottom hole of the transom rail to the spring pin at the bottom of the ram and drive the pin out (Fig. 34). Then insert the driver bar through the top holes of the motor rail and transom rail to the spring pin at the top of the actuator and drive the pin out (Fig. 35). Remove the actuator from the bottom of the PT-130 (Fig. 36).



FIG. 35

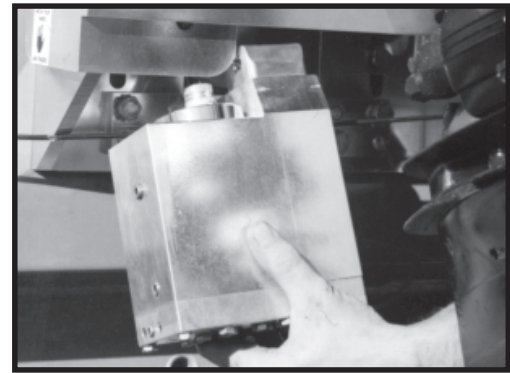


FIG. 36

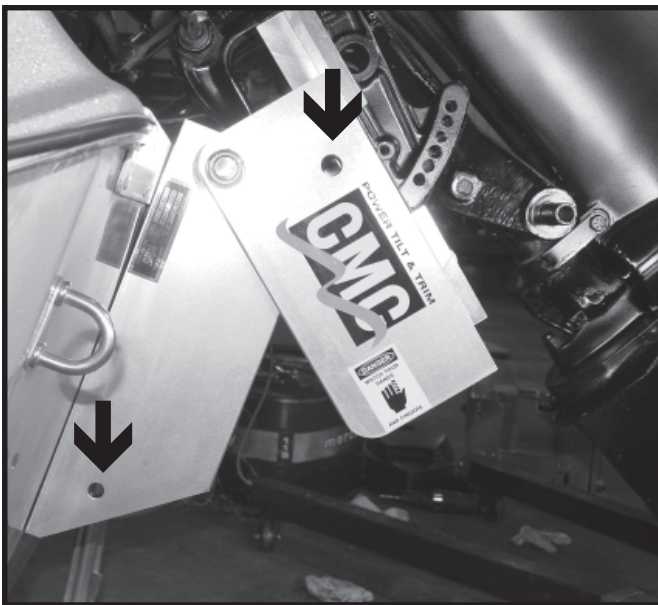


FIG. 33

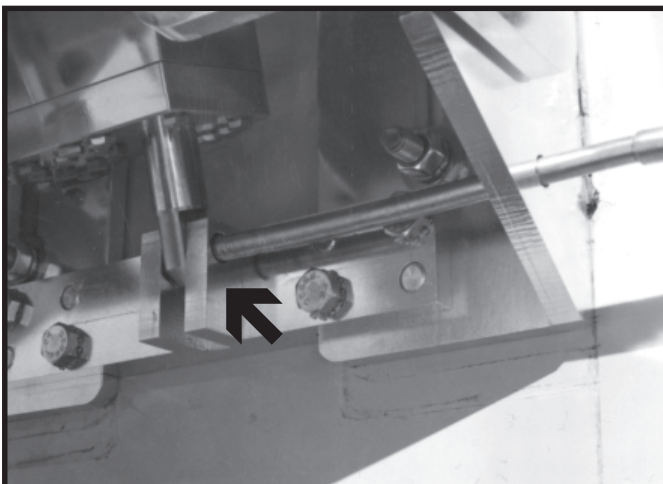


FIG. 34

## EMERGENCY RELIEF VALVE

Your PT-130 actuator features an emergency relief valve that will allow you to manually raise and lower the tilt and trim if it becomes necessary due to power loss or actuator malfunction. This emergency relief valve is a 1/4 hex screw head located at the bottom of the actuator toward the port side (Fig. 37). Gradually turn the relief valve counter clockwise 1/2 to 1 full turn (NO MORE THAN 1 FULL TURN). This will allow you to manually raise or lower PT-130.

**CAUTION: IF THE PT-130 IS IN THE UP POSITION WHEN IT BECOMES NECESSARY TO RELIEVE THE PRESSURE IN THE SYSTEM, FIRST SUPPORT THE UNIT WITH A HOIST OR THE AID OF ANOTHER PERSON. RELIEVE THE PRESSURE AND SLOWLY LOWER THE UNIT. EXERCISE CAUTION TO AVOID INJURY.**

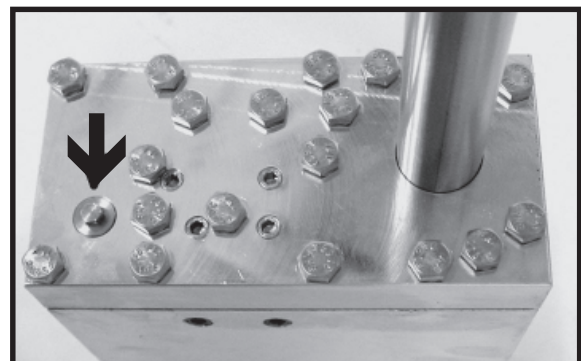


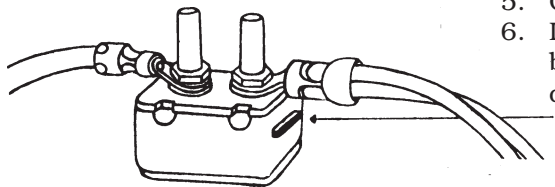
FIG. 37

# TROUBLESHOOTING

If problems should occur, follow the check list below step by step. This should eliminate any simple problems that might arise.

## PROBLEM:

Will not run in either direction



1. Check for dead battery
2. Reset the circuit breaker at + battery terminal
3. Check continuity through toggle switch
4. Check wire continuity from switch to connector
5. Check for 12 volts at toggle switch, wire labeled +
6. Disconnect the actuator cordset from the relay wire assembly and jump the actuator directly to the battery. If it doesn't run, replace the actuator.

## CIRCUIT BREAKER RESET BUTTON

Will not run in one direction

1. Check toggle switch
2. Check wire continuity from toggle switch to connector

Actuator runs but unit does not move up or down

1. Check hydraulic fluid level.

Unit at up position leaks down to bottom

1. Run unit up and down several times. Could have debris in check valve. If this does not correct the problem, replace actuator.

Unit at up position will not come down

1. Make sure there is no foreign object binding the unit. If the actuator is running and there is no foreign object binding the unit, replace actuator.

Unit will not go up under power or goes up very, slowly while not under power

**NOTE:** To make sure the PT-130 is not trimming under power, please run your boat at the speed you would like to trim with the PT-130 trimmed all the way in. Hold the switch up for several seconds to trim out. Stop the boat and check the position of the PT-130. See diagram No. 1, page 6 to compare position for maximum trim range.

1. Check with ammeter at + wire to see if registering 50 - 60 amps when unit is run to top and is "bogging" down. (unit will pull 25 - 40 amps during up and down motion)
2. If a smaller gauge wire has been spliced into wire harness, this could be the cause.
3. Check with voltmeter to see if getting 12 volt from battery. Also check it as the PT-130 is running. If voltage drops more than 1 volt, the battery is not supplying enough power.
4. If the actuator "free wheels" and does not leak down, the system is low on fluid or has air in system. See "servicing" page 7 for instructions to refill and bleed air.

## PARTS LIST

PART NO.	DESCRIPTION	PART NO.	DESCRIPTION
7050	Actuator	6009	Top Actuator Spring Pin
7123	Up-Down Toggle Switch	6009	Bottom Actuator Spring Pin
13022	Transom Clamp Motor Adapter	6021	Nylatron Washer
13032	Transom Spacer For Pontoon	51207	Trim Gauge Conversion Kit
51127	Trim Gauge	7186	Circuit Breaker
51101	Trim Gauge Setting Unit	6033	1/2" - 13 x 3 Stainless Steel Bolt
7014	Wire Assembly	6035	Stainless Steel 1/2" Hex Nut
7122	12V 40A Relay	6034	Stainless Steel Flat Washer
20220	Trim Button Switch (optional)	6036	Stainless Steel Lock Washer

# COOK MANUFACTURING CORPORATION

3920 SOUTH 13th • DUNCAN, OKLAHOMA 73533

(580) 252-1699

## ***LIMITED WARRANTY***

New PT-130 Power Tilt & Trim Units are warranted by the manufacturer for one year from date of purchase against defects in workmanship and/or materials in the hydraulic system and five years from the date of purchase against defects in workmanship and/or material in the structure.

This warranty means that only the parts that prove defective during the period of warranty will be repaired or replaced at our option. Cook Manufacturing Corporation will accept only parts returned for warranty prepaid from initial purchaser and return the repaired or replaced parts freight collect.

Avoid tampering with the Hydraulic Actuator, if a warranty claim is to be made. The warranty is void on any hydraulic actuator returned that shows signs that it has been dismantled or the electrical cordset from the motor has been cut.

A return authorization number must be issued from the factory prior to the return of defective parts. Call toll free in the continental United States 1-800-654-3697; outside the United States Call 580-252-1699 to obtain the return authorization.

There are no warranties which extend beyond the description on the face hereof. No one has authority to make any representations concerning the operation of CMC PT-130 Power Tilt & Trim Units except those made in writing by Cook Manufacturing Corporation.

This warranty does not apply for any racing applications or if damage occurs because of accident, improper handling or operation, abuse or misuse.

All liability for any incidental or consequential damage is expressly excluded herefrom.

In order to obtain the benefit of this warranty and agreement, the warranty card found in the centerfold of this manual must be completely filled out and mailed within 30 days to Cook Manufacturing Corporation.

This warranty applies to original ownership only.